

Full Spectrum LED Tape Light



Mimicking the spectrum of natural sun light, deliver lumen up to 469lm/FT, spectrum from 380nm to 780nm, with average Ra more than 95, this full spectrum strip light is a perfect lighting choice for professional photography studio, film studio



PRODUCT CODE	CCT	LUMENS/FT	EFFICACY
HL-24V-FF2835-120-27	2700K	423lm	90lm/W
HL-24V-FF2835-120-50	5000K	469lm	97lm/W

PHYSICAL

Operating Temp	-15°F to +140°F (-26°C to +60°C)
Class II Max Run	18.5 ft.
Ra	95+
Cut Length	1.97 in (50mm)
Environment	IP20
Mounting	Adhesive Tape
Package Length	16.4 ft. (5m)
Width	0.39 in (10mm)
Height	0.06 in (1.5mm)

ELECTRICAL

Input Voltage	24V DC
Power Consumption	<4.7 w/ft
Max. Run Length	46 ft.
LEDs/Meter	120
Lamp Life	50,000+ hours
Wire Size	2464 20 AWG, 2 wire
Dimming	MLV / ELV / 0-10V
Certifications	UL Listed
Warranty	5 years

1. Lumen value measured in accordance to IES LM-80-08. LED chips have a luminous flux range with a tolerance of +/- 5%.
2. Each maximum run requires a dedicated power feed from the driver. Do not extend beyond the recommended maximum run length. Max run may exceed Class 2 limit. Actual wattage may differ from calculated wattage due to voltage drop across run.
3. Do not install product in an environment outside the listed ambient temperature. Exceeding the maximum ambient temperature may damage LED chips, reduce the total lamp life, lumen output, and/or adversely impact color consistency.
4. Actual efficacy value is dependent to specified LED driver (power supply). An estimated efficacy value can be calculated as follows: Lumen value divided by average power consumption per foot.
5. Actual color may vary from what is pictured on this sheet and other print materials due to the limitations of photographic processes.



Full Spectrum LED Tape Light

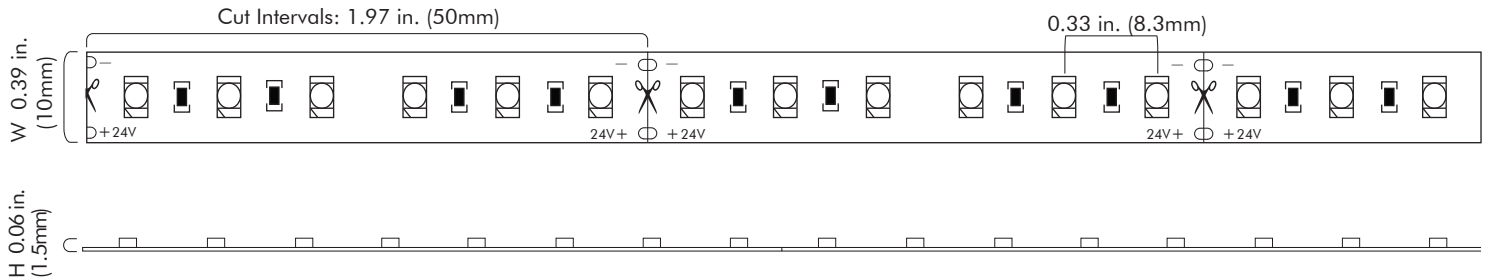

MECHANICAL DIAGRAMS



Choose Your Wire

PRODUCT IMAGE	SKU	LENGTH AVAILABLE
	Female DC Connector HL-DCCF	6 inch, 1ft, 2ft & 10ft
	Male DC Connector HL-DCCM	6 inch, 1ft, 2ft & 10ft
	20 AWG 2 Cores Cable Wire HL-W20-2	Custom ordered

Compatible Channel Options

Our anodized aluminum channels are a must have accessory for your stylish and elegant linear light fixture. These channels will help dissipate the heat, cooling and prolonging the LED tape light lifespan. They also diffuse the light with lenses and protect the tape light from dust and debris.

PRODUCT IMAGE	SKU	MATERIAL	DIMENSION	DOTTING LEVEL
	Surface 1715 HL-ACL-S1715	Silver Anodized Aluminum		0
	Surface 2114 HL-ACL-S2114	Silver Anodized Aluminum		0
	Surface 2626 HL-ACL-S2626	Silver Anodized Aluminum		0*
	Recessed 2515 HL-ACL-R2515	Silver Anodized Aluminum		0
	Recessed 2810 HL-ACL-R2810	Silver Anodized Aluminum		1
	Corner 1616 HL-ACL-C1616	Silver Anodized Aluminum		1
	Corner 3030 HL-ACL-C3030	Silver Anodized Aluminum		0

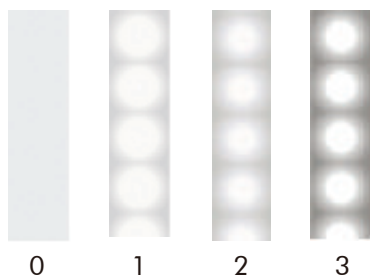

The dot level shows the intensity of hotspots in the combinations of Hilite LED tape light and channels with a frosted diffuser.

Note:

The value states perceived, not absolute, dot levels measured by the human eye and not a machine, which may differ slightly for individuals.

*: suggest to use double rows of LED tape light

Power Supply Options

The following Listed LED Power Supplies are recommended for compatibility. They are provided for reference only. For complete specifications of compatible products, please check on www.hiliteleds.com or ask your account manager.

ELECTRONIC MLV DIMMABLE POWER SUPPLY

Dims from 100-1%. Compatible with MLV / Incandescent TRIAC dimmer switch.

PRODUCT IMAGE	SKU	WATTAGE	OUTPUT VOLTAGE	OUTPUT CURRENT	INPUT VOLTAGE	DIMENSION	CERTIFICATIONS
	HL-PS-D20V24	20W	24V DC	0.87A	120V AC	6.77 x 2.67 x 1.30 in.	UL 8750 Class 2 Nema 3R
	HL-PS-D40V24	40W	24V DC	1.75A			
	HL-PS-D60V24	60W	24V DC	2.63A			
	HL-PS-D75V24	75W	24V DC	3.30A			
	HL-PS-D96V24	96W	24V DC	4.00A			

WIRING DIAGRAM

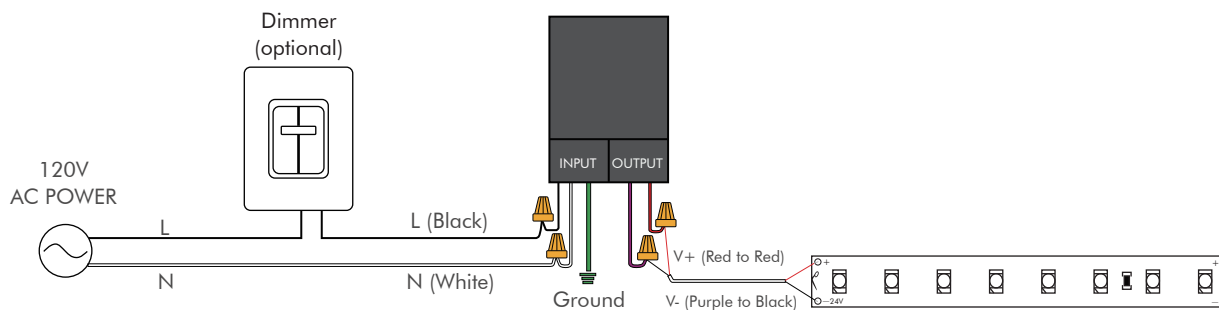

0-10V DIMMABLE POWER SUPPLY

Flicker-Free Dimming down to 1% (0-10V). Integrated Junction Box with Multiple $\frac{7}{8}$ " Knock-Outs.

PRODUCT IMAGE	SKU	WATTAGE	OUTPUT VOLTAGE	OUTPUT CURRENT	INPUT VOLTAGE	DIMENSION	CERTIFICATIONS
	HL-PS-030V24	30W	24V DC	1.30A max	120V - 277V AC	11.4 x 2.36 x 1.4 in.	UL 8750 Class 2 Class P
	HL-PS-060V24	60W	24V DC	2.60A max			
	HL-PS-096V24	96W	24V DC	4.10A max			

Full Spectrum LED Tape Light



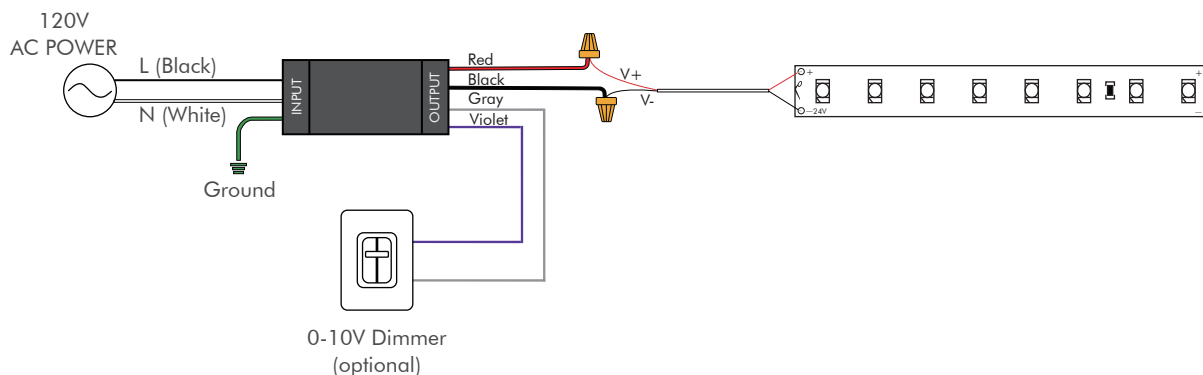

WIRING DIAGRAM





ON/OFF POWER SUPPLY (can be paired with a PWM single color dimmer)

24V DC Constant Voltage power supply, compatible with HL-M1 +M3.

PRODUCT IMAGE	SKU	WATTAGE	OUTPUT VOLTAGE	OUTPUT CURRENT	INPUT VOLTAGE	DIMENSION	CERTIFICATIONS
	HL-PS-L35V24	35W	24V DC	1.50A	90V -	5.83 x 1.57 x 1.18 in.	UL Class 2
	HL-PS-L60V24	60W	24V DC	2.50A	264VAC	6.40 x 1.67 x 1.26 in.	UL Class 2
	HL-PS-L96V24	96W	24V DC	4.10A	120V - 277VAC	11.40 x 2.36 x 1.4 in.	UL 8750/ Class 2/ Class P

PLUG & PLAY ADAPTOR (can be paired with in-line knob dimmer)

PRODUCT IMAGE	SKU	WATTAGE	OUTPUT VOLTAGE	OUTPUT CURRENT	INPUT VOLTAGE	DIMENSION	CERTIFICATIONS
	HL-PS-A24V24	24W	24V DC	1.00A	100V - 240VAC	3.19 x 1.93 x 2.32 in.	ETL Class 2
	HL-PS-A36V24	36W	24V DC	1.50A	100V - 240VAC	3.98 x 2.01 x 2.13 in.	ETL Class 2
	HL-PS-A60V24	60W	24V DC	2.50A	100V - 240VAC	4.61 x 2.05 x 1.38 in.	ETL Class 2

Solder Free Quick Connector

PRODUCT IMAGE	SKU	DESCRIPTION
	HL-TBC	Multi Use Terminal Connector provides secure connection between LED tape lights
	HL-CTT-S10	Tape to tape connector, with windows
	HL-CTW-6S10	Tape light splice connector, with 6" wire
	HL-CTW-36S10	Tape light splice connector, with 36" wire
	HL-CTT-6S10	Tape to Tape Extension Connector, with 6" wire
	HL-CTT-36S10	Tape to Tape Extension Connector, with 36" wire
	HL-DCCFM	Female Male DC Extension Lengths available: 3ft, 4ft & 10ft
	HL-DCCS2	1 to 2 Way DC Splitter 1 Female, 2 Male
	HL-DCCS4	1 to 4 Way DC Splitter 1 Female, 4 Male
	HL-DCCS8	1 to 8 Way DC Splitter 1 Female, 8 Male
	HL-DCCFH	Female to Hardwire Adapter
	HL-DCCMH	Male to Hardwire Adapter

Tape Light Fastener

PRODUCT IMAGE	SKU	DESCRIPTION
	HL-TFN-10	Mounting Clip

SAFETY / WARNINGS / DISCLOSURES

1. Install in accordance with national and local electrical code regulations.
2. This product is intended to be installed and serviced by a qualified, licensed electrician.
3. Only install with a listed Class 2 DC Constant Voltage LED Driver.
4. Tape light, and attached wire leads, are not rated for inwall installation unless otherwise noted.
5. Do not install in environment where LED chips are exposed to direct sunlight as damage to the phosphor will occur.
6. Do not modify or disassemble product beyond instructions or the warranty will be void.
7. Tape light must be handled with care. Excessive handling, bending, and pressure may damage the product, voiding the warranty.
8. Do not install indoor LED tape light products in outdoor/ wet location environments. Only wet location tape light models are rated for outdoor / wet locations.
9. Uncoil flexible light prior operation, failure to do so may cause excessive heat which will damage the product.
10. We reserve the right to modify and improve the design of our fixtures without prior notice. We can not guarantee to match existing installed fixtures for subsequent orders or replacements in regards to product appearance, CCT, or lumen output.